



SPECIFICHE

Piantane

Chrome

Ingresso a 2 vie

Imballo: 24 x 25 x 8 cm / 0,0048 m³ / 1,59 kg

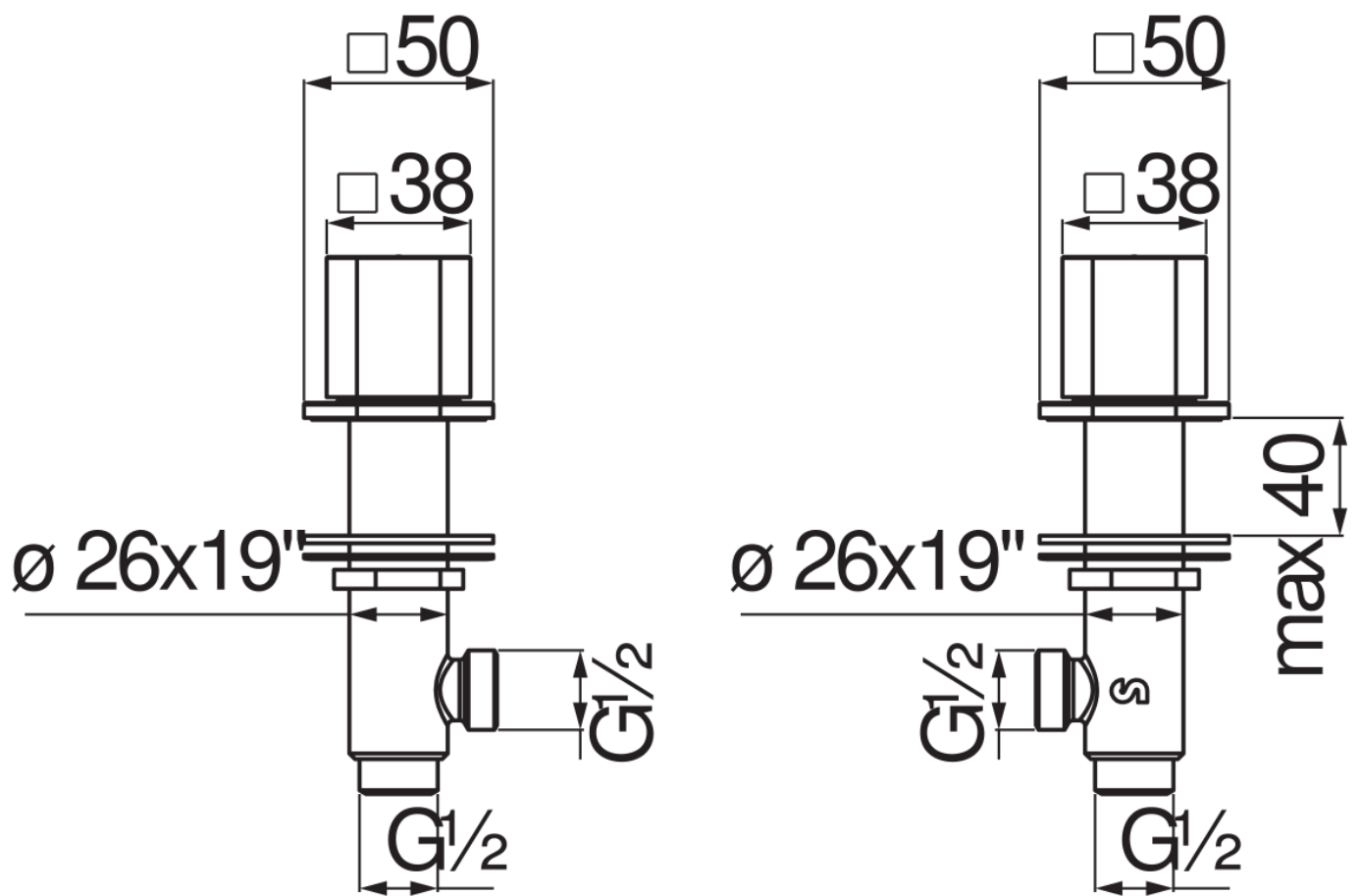

DIAGRAMMA DI PORTATA: ACQUA CALDA/FREDDA

